

High security cylinder TK100



ASSA ABLOY

Technical data

TK100 cylinders have been designed with the most exclusive protection systems. This newly version integrates, in addition of the patent, an exclusive orbit combination system which fully surpasses the maximum key security grade specified in the standard regulation. In addition to that, this new manufacturing concept improves against non-destructive opening methods such as bumping, picking...etc. To complete the maximum security grade in all its extension, this model incorporates extra protections to resist the most usual attacks applied when breaking in.

In terms of drill protections, TK100, in addition of incorporating hardened pins, includes a new protector shield integrated. With this new cylinder, TESA starts a new gait which leads the future in all the cylinder range.

Features

- » Type of key: Flat, non-duplicable and patented.
- » Number of rows : 2
- » Number of pins: 10 + 2 security sensors in the key.
- » Technology: DROP ORBITAL (TESA Exclusive)
- » Combinatory: It reaches way above the degree 6 of the standard.
- » Masterkey systems: Superior capacity with no need to use passive pins.
- » Resistance to corrosion and temperature: Degree C
- » Advanced antibump.
- » Top antipick protection.
- » Antipick protection way above the maximum degree specified by the European standard.
- » Antiextraction rotor.
- » Corona pins on rotor front.
- » The bridge of the body features preinstalled reinforced steel.
- » Resistance: 200,000 cycles.
- » Preinstalled double-security clutch.
- » 5 narrow-neck keys per cylinder.
- » New, ergonomic key design.
- » Key duplication and cylinders are protected via ownership card.
- » Certified according to the EN 1303 standard.

Options

- » Finishes: Brass / Nickel.
- » Cam: DIN R15 and R13.
- » Formats available: Key different, master keyed, key alike and specific codes.
- » A wide range of sizes and profiles.
- » Colour points to differentiate master key levels.

Master key systems

The new orbit permutation system TESA has patented gives TK100 the highest level of security ever seen in the market. For that reason, TK100 is the ideal system for master keyed requirements. It does not matter how complex the master keying is. TK100 will solve, widely, every type of lock charts.



European standard regulation

TK100 widely surpasses the different laboratory tests specified in the standard European regulation.

	1	6	0	B	0	C	6	D
Key resistance (Grade 0-1)								
Lifespan (Grade 4-6)								
Door mass (Not applied in cylinders)								
Fire resistance (Grade 0-A-B)								
Safety of the people (Not applied in cylinders)								
Corrosion and temperature resistance (Grade 0-A-B-C)								
Key related security (Grade 1 to 6)								
Attack resistance (Grade 0-A-B-C-D)								

Recommendations.

- » Use TESA lubricant to lengthen the maximum lifespan of the cylinder.
- » TESA recommends to the user of the TK100 to keep the property card in a safe and secure location. Only by presenting this card, can one obtain key and cylinder copies.
- » For safety reasons, when you install a new cylinder, remember that once installed, it should not project more than 1mm.







D

High security cylinder TK100

Patented

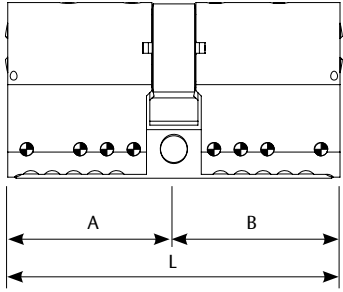
European profile

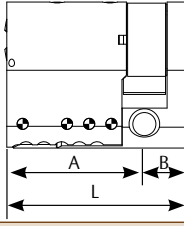

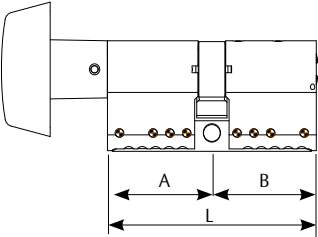
Double european		L	A	B	Cam = 15 mm	Finish	Short cam Cam = 13,2 mm	Finish
		60	30	30	TK15 30 30 L	Brass	MK15 30 30 N	Nickel
		65	30	35	TK15 30 35 L	Brass	MK15 30 35 N	Nickel
		70	30	40	TK15 30 40 L	Brass	MK15 30 40 N	Nickel
		70	35	35	TK15 35 35 L	Brass	MK15 35 35 N	Nickel
		75	30	45	TK15 30 45 L	Brass	MK15 30 45 N	Nickel
		75	35	40	TK15 35 40 L	Brass	MK15 35 40 N	Nickel
		80	30	50	TK15 30 50 L	Brass	MK15 30 50 N	Nickel
		80	35	45	TK15 35 45 L	Brass	MK15 35 45 N	Nickel
		80	40	40	TK15 40 40 L	Brass	MK15 40 40 N	Nickel
		85	35	50	TK15 35 50 L	Brass	MK15 35 50 N	Nickel
		90	30	60	TK15 30 60 L	Brass	MK15 30 60 N	Nickel
		90	35	55	TK15 35 55 L	Brass	MK15 35 55 N	Nickel
		90	40	50	TK15 40 50 L	Brass	MK15 40 50 N	Nickel
		90	45	45	TK15 45 45 L	Brass	MK15 45 45 N	Nickel
		100	30	70	TK15 30 70 L	Brass	MK15 30 70 N	Nickel
		100	40	60	TK15 40 60 L	Brass	MK15 40 60 N	Nickel
		100	50	50	TK15 50 50 L	Brass	MK15 50 50 N	Nickel
		110	30	80	TK15 30 80 L	Brass	MK15 30 80 N	Nickel
		110	50	60	TK15 50 60 L	Brass	MK15 50 60 N	Nickel
		120	30	90	TK15 30 90 L	Brass	MK15 30 90 N	Nickel
		120	40	80	TK15 40 80 L	Brass	MK15 40 80 N	Nickel
		120	60	60	TK15 60 60 L	Brass	MK15 60 60 N	Nickel
		130	30	100	TK15 31 00 L	Brass	MK15 31 00 N	Nickel
		140	40	100	TK15 41 00 L	Brass	MK15 41 00 N	Nickel
		150	50	100	TK15 51 00 L	Brass	MK15 51 00 N	Nickel
		160	60	100	TK15 61 00 L	Brass	MK15 61 00 N	Nickel
Single european. (8 positions standard)		L	A	B	Cam = 15 mm	Finish	Cam = 13,2 mm	Finish
		40	30	10	TK15 30 10 L	Brass	MK15 30 10 N	Nickel
		45	35	10	TK15 35 10 L	Brass	MK15 35 10 N	Nickel
		50	40	10	TK15 40 10 L	Brass	MK15 40 10 N	Nickel
		60	50	10	TK15 50 10 L	Brass	MK15 50 10 N	Nickel
		70	60	10	TK15 60 10 L	Brass	MK15 60 10 N	Nickel
		80	70	10	TK15 70 10 L	Brass	MK15 70 10 N	Nickel
		90	80	10	TK15 80 10 L	Brass	MK15 80 10 N	Nickel
		100	90	10	TK15 90 10 L	Brass	MK15 90 10 N	Nickel
Knob european.		L	A	B	Cam = 15 mm	Finish	Cam = 13,2 mm	Finish
		60	30	30	TK1B 30 30 L	Brass	MK1B 30 30 N	Nickel
		65	30	35	TK1B 30 35 L	Brass	MK1B 30 35 N	Nickel
		70	35	35	TK1B 35 35 L	Brass	MK1B 35 35 N	Nickel
		70	40	30	TK1B 40 30 L	Brass	MK1B 40 30 N	Nickel
		80	30	50	TK1B 30 50 L	Brass	MK1B 30 50 N	Nickel
		80	40	40	TK1B 40 40 L	Brass	MK1B 40 40 N	Nickel
		85	35	50	TK1B 35 50 L	Brass	MK1B 35 50 N	Nickel
		90	30	30	TK1BTB3030L	Brass	MK1BTB3030N	Nickel
		90	35	30	TK1BTB3530L	Brass	MK1BTB3530N	Nickel



* To process "master keyed" and "key alike" orders add either AM or KA in each part number, respectively.

** The butler system lets operate with the key form the outside even if knob is blocked from the inside. Is a solution thought for schools, geriatrics.etc.

High security cylinder TK100

Patented

European profile

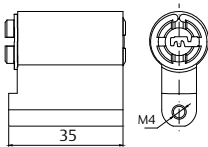
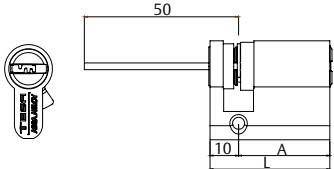
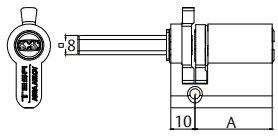
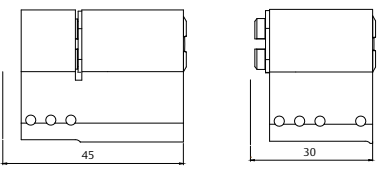
Padlock exchangeable		L	A	B	Product code	Finish		
		-	-	-	TK15CL55L	Brass		
		-	-	-	TK15CL55N	Nickel		
Adjustable european cylinder		L	A	B	Product code	Finish		
	40	30	10	TK1R3010L	Brass			
	40	30	10	TK1R3010N	Nickel			
	50	40	10	TK1R4010L	Brass			
	50	40	10	TK1R4010N	Nickel			
Euro cylinder for lock set 3520		L	A	B	Product code	Finish		
	40	30	10	TK12520L	Brass			
	40	30	10	TK12520N	Nickel			
European modular heads (to be used with the modular cases)		L	A	B	Product code	Finish	Product code	Finish
	30	30	--	TK1530LMD	Brass	TK1530NMD	Nickel	
	45	45	--	TK1545LMD	Brass	TK1545NMD	Nickel	
	60	30	30	TK1560LMD	Brass	TK1560NMD	Nickel	
	75	30	45	TK1575LMD	Brass	TK1575NMD	Nickel	
	90	45	45	TK1590LMD	Brass	TK1590NMD	Nickel	

* To process "master keyed" and "key alike" orders add either AM or KA in each part number, respectively.

D

High security cylinder TK100

Patented

Round profiles

Round for TS lock sets		Ø	Inside length	Outside length	Product code	Finish
Inside		28	30	45	TK1TS40LC	Brass
		28	30	45	TK1TS40LT	Brass
Outside						

The ref. LC includes external shield and fixing plate.

Round for TS lock sets		Ø	Inside length	Outside length	Product code	Finish
Inside		28	30	Adjustable	TK1TSRFLC	Brass
		28	30	Adjustable	TK1TSRFLT	Brass
Outside						

The ref. LC includes external shield and fixing plate.

Multifort lock		Ø	Inside length	Outside length	Product code	Finish
		28	31	Adjustable	TK1TSCOLC	Brass
		28	31	Adjustable	TK1TSCOL	Nickel

The ref. LC includes external shield and fixing plate.

Adjustable round cylinder		Ø	Inside length	Outside length	Product code	Finish
		28	-	Adjustable	55TK15LT	Brass
		28	-	Adjustable	55TK15LN	Nickel

* To process "master keyed" and "key alike" orders add either AM or KA in each part number, respectively.

High security cylinder TK100

Patented

Round profiles

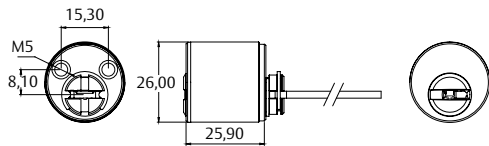

* Tubes to extend the length of the cylinder are sold apart
Part number with "H" = AUMON / Serraller = "V"

Round for AUMON & Serraller locks		Ø	Inside length	Outside length	Product code	Finish
		26	-	Adjustable	TK15REGAUHL	Brass
		26	-	Adjustable	TK15REGAUHN	Nickel
		26	-	Adjustable	TK15REGAUVL	Brass
		26	-	Adjustable	TK15REGAUVN	Nickel
Accesories	Lenght			Product code	Finish	
TUBE	22			TUB2526L22L	Brass	
TUBE	22			TUB2526L22N	Nickel	

High security cylinder TK100

Patented

Round profiles

682			Metric	Type	Function	Product code	Finish
	23	Mechanic	-	682M23TK1NM	Nickel		
	23	Electric	1 switch & return	682M23TK1CR	Nickel		
	27	Mechanic	-	682TK1NM	Nickel		
	27	Electric	1 micro switch	682TK11C	Nickel		
	27	Electric	1 switch & return	682TK1CR	Nickel		
	27	Electric	2 micro switches	682TK12C	Nickel		
	27	Electric	2 micro switches	682TK12C	Nickel		

* To process "master keyed" and "key alike" orders add either AM or KA in each part number, respectively.