

Key-in-lever locksets

Squaring the advantages

- » Multifunctional mechanism for knob or lever, with high component robustness and soft operation.
- » High-end commercial and residential applications.

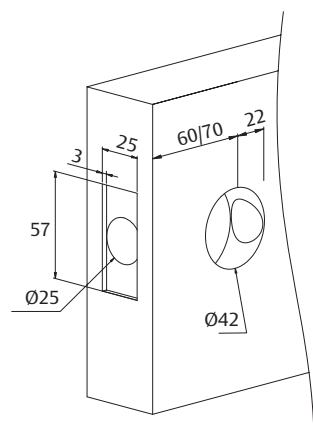



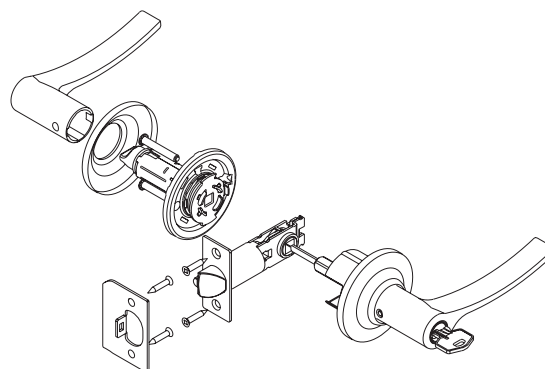

Dimensions in mm

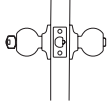
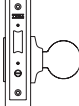

Features	Standard	Special
Technical features	Anti-thrust security pin for functions 0, 1 and 2.	
Anti-corrosion resistance ASTM B117/90	CM,NS144 hours LP,LM 96 hours	
Espesor puerta	33-45 mm for handles 33-52 mm for knobs	
ANSI A156.2	Grade 2: 400.000 cycles	
UL		Up to 1,5 hours of Fire proof
Cylinder	TE5, 5 pin cylinder with 3 keys	Security Cylinder: TD5, TD60, T60, T80, TX80, TK6 Masterkeying and keyed alike
Latch	60/70 Ajustable backset. Latchbolt projection 12,5 mm	
Accessories	Strike, screws, instructions and assembly template.	
Packaging units	20	
Reversibility	All knobsets are reversible - Beware with the hands of some handles	

Key-in-lever locksets

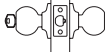
Functions

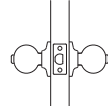
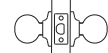
Function	Description	Function	Description
	00 ENTRANCE LOCK: both sides are locked and unlocked by outside key or inside turn-button.		20 ENTRANCE LOCK: both sides are locked and unlocked by outside key or inside knob. Mortise lock. Applicable with electric strike.
	01 ENTRANCE LOCK: locked and unlocked only by outside key. If locked, inside knob/lever is not active.		31 SINGLE DUMMY TRIM: screw attachment from inside of the door.
	02 STOREROOM LOCK: outside fixed, entrance by key only. Inside always unlocked.		34 ENTRANCE LOCK: always unlocked. Applicable to mortise locks.
	03 BED AND BATHROOM LOCKS: both sides are locked and unlocked by the inside turn-button. Emergency release outside.		
	05 PASSAGE LOCK: both sides always unlocked.		



Code interpretation

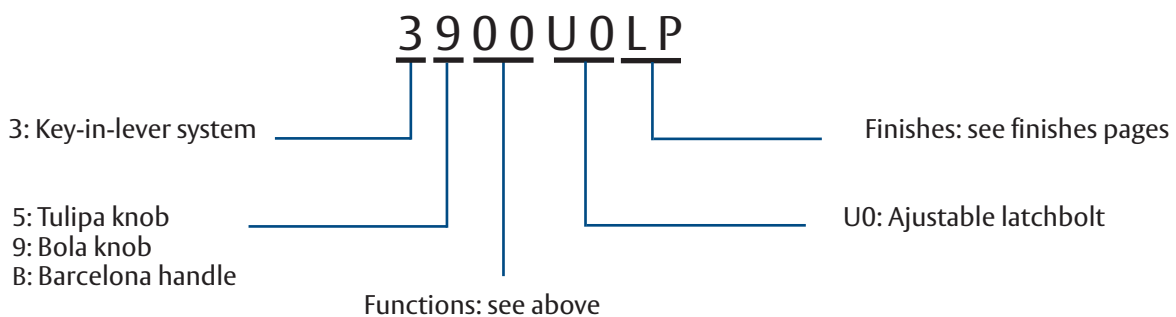





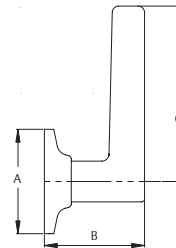

Key-in-lever locksets

Handle model

Model	A	B	C	3B Barcelona
Barcelona	65	62	109	







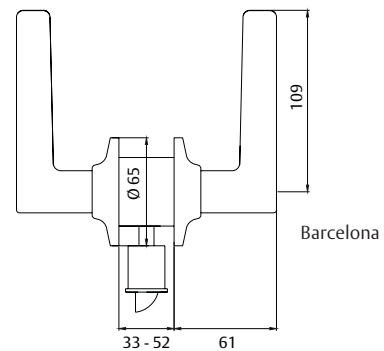









3B Barcelona series

Entrance	Function	Backset	Finish	Packging
 	3B00	U0	CM - LM - LP - NS BL - NE	20
Bathroom	Function	Backset	Finish	Packging
 	3B03	U0	CM - LM - LP - NS BL - NE	20
Passage	Function	Backset	Finish	Packging
 	3B05	U0	CM - LM - LP - NS BL - NE	20



39 Bola series

Entrance	Function	Backset	Finish	Packging
 	3900	U0 UV	CM - LM - LP - NS BL - NE	20
Entrance	Function	Backset	Finish	Packging
 	3901	U0	CM - LM - LP - NS BL - NE	20
Storeroom	Function	Backset	Finish	Packging
 	3902	U0	CM - LM - LP - NS BL - NE	20
Bathroom	Function	Backset	Finish	Packging
 	3903	U0 UV	CM - LM - LP - NS BL - NE	20
Passage	Function	Backset	Finish	Packging
 	3905	U0 UV	CM - LM - LP - NS BL - NE	20
Entrance	Function	Backset	Finish	Packging
 	3920	50	CM - LM - LP - NS BL - NE	20
Single pull knob	Function	Backset	Finish	Packging
	3931	00	CM - LM - LP - NS BL - NE	20
Single sq.spindle	Function	Backset	Finish	Packging
	3934	00	CM - LM - LP - NS BL - NE	20

