

# Sistemas cuadradillo

## Ventajas al cuadrado

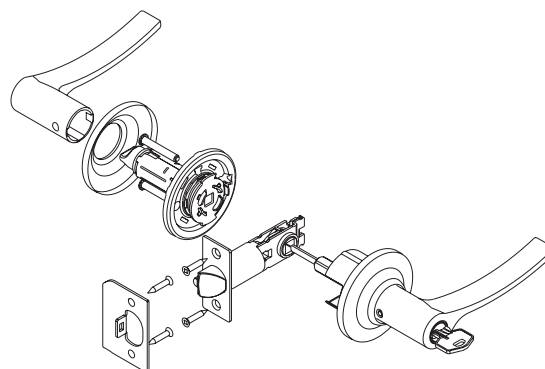

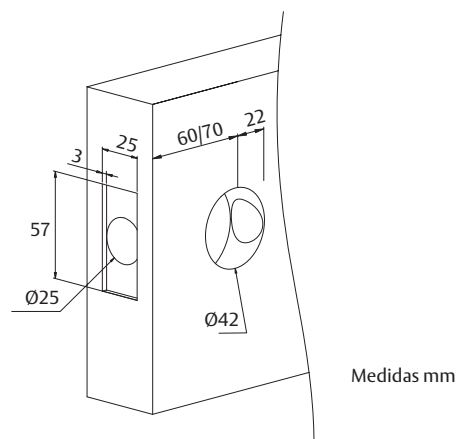





- » Mecanismo multifuncional que sirve tanto para pomo como para manilla, de gran robustez de componentes y accionamiento muy suave.
- » Es aplicable a edificios institucionales de alto tráfico de personas y edificios residenciales de tráfico medio.

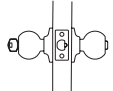

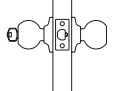
Características	Estandar	Especial
Características técnicas	Picaporte con dispositivo de seguridad antitarjeta en funciones 0, 1 y 2	
Resistencia anti-corrosión s/ASTM B 117/90	CM,NS ....144 horas LP,LM ..... 96 horas	
Espesor puerta	33-45 mm manillas 33-52 mm pomos	
ANSI A156.2	Grado 2: 400.000 ciclos	
UL		Hasta 1,5 horas de exposición al fuego
Cilindro	TE5, 5 pitones activos y 3 llaves	Cilindro de seguridad: TD5, TD60, T60, T80, TX80, TK6 Llaves iguales y amaestramientos
Picaporte	Entrada 60 ó 70 mm - unificado Saliente 12,5 mm	
Accesorios	Cerradero, tornillos, instrucciones y plantilla de montaje	
Uds. embalaje	20	
Reversibilidad	Todos los pomos son reversibles - Ojo con las manos de algunas manillas	

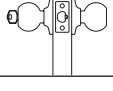
# Sistemas cuadradillo

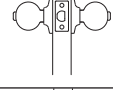
## Funciones

Función	Descripción	Función	Descripción
	00 ENTRADA: ambos lados son condenados y descondenados por la llave exterior o la muletilla interior.		20 ENTRADA: condena y descondena por la llave exterior y el pomo interior. Picaporte-palanca. Aplicable a portero automático.
	01 ENTRADA: condena y descondena sólo por la llave exterior. El interior queda condenado.		31 TIRADOR FIJO: fijación pasante desde el interior.
	02 AULAS: el exterior fijo, sólo se abre con llave. El interior siempre se puede abrir.		34 ENTRADA: siempre libre, aplicable a cerraduras de embutir. No incluye cerradura.
	03 BAÑOS Y DORMITORIOS: ambos lados son condenados y descondenados por la muletilla interior. Posibilidad de descondena exterior mediante dispositivo de emergencia.		
	05 PUERTAS DE PASO: ambos lados siempre libres.		



## Interpretación del código

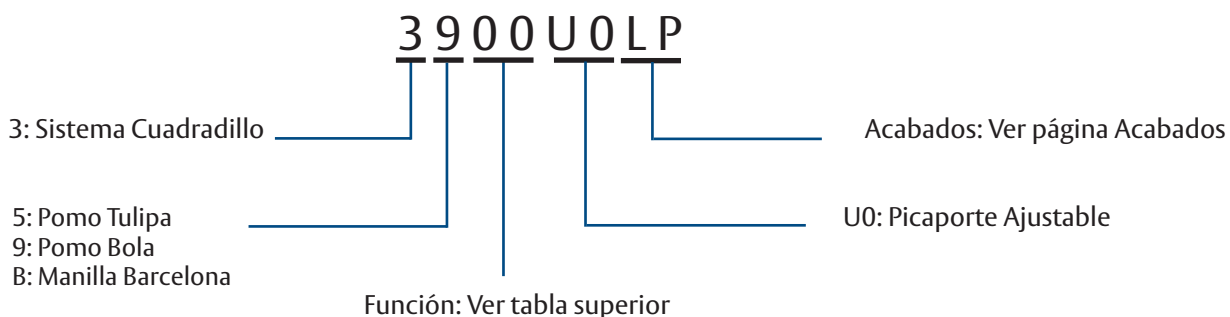





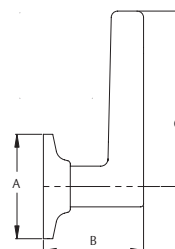

# Sistema cuadradillo

## Modelos de manillas

Modelo	A	B	C	3B Barcelona
Barcelona	65	62	109	







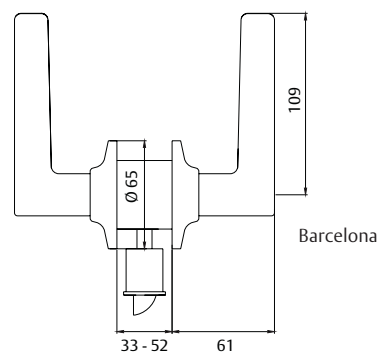









## Serie Barcelona 3B

Entrada	Función	Entrada	Acabado	Embalaje
 	3B00	U0	CM - LM - LP - NS BL - NE	20
Baño	Función	Entrada	Acabado	Embalaje
 	3B03	U0	CM - LM - LP - NS BL - NE	20
Paso	Función	Entrada	Acabado	Embalaje
 	3B05	U0	CM - LM - LP - NS BL - NE	20



## Serie Bola 39

Entrada	Modelo	Entrada	Acabado	Embalaje
 	3900	U0 UV	CM - LM - LP - NS BL - NE	20
Puertas a condonar	Modelo	Entrada	Acabado	Embalaje
 	3901	U0	CM - LM - LP - NS BL - NE	20
Aula	Modelo	Entrada	Acabado	Embalaje
 	3902	U0	CM - LM - LP - NS BL - NE	20
Baño	Modelo	Entrada	Acabado	Embalaje
 	3903	U0 UV	CM - LM - LP - NS BL - NE	20
Paso	Modelo	Entrada	Acabado	Embalaje
 	3905	U0 UV	CM - LM - LP - NS BL - NE	20
Entrada	Modelo	Entrada	Acabado	Embalaje
 	3920	50	CM - LM - LP - NS BL - NE	20
Pomo tirador	Modelo	Entrada	Acabado	Embalaje
	3931	00	CM - LM - LP - NS BL - NE	20
Pomo - cuadradillo	Modelo	Entrada	Acabado	Embalaje
	3934	00	CM - LM - LP - NS BL - NE	20

