

Pênes demi-tour et gâches

Pêne demi-tour à fouillot carré

| Standard | Modèle | Finition | Axe |
|---|--------|----------|-------|
|  | P030U0 | LP - CR | 60/70 |
| | P03020 | LP - CR | 127 |
| Rond 1/2 | Modèle | Finition | Axe |
|  | P030U2 | LP - CR | 60/70 |
| | | | |
| Dispositif de sécurité | Modèle | Finition | Axe |
|  | P031U0 | LP - CR | 60/70 |
| | P03120 | LP - CR | 127 |
| Disp. séc. et rond 1/2 | Modèle | Finition | Axe |
|  | P031U2 | LP - CR | 60/70 |
| | | | |

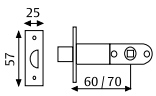
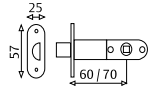
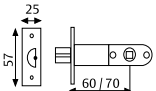
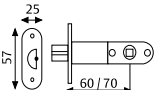
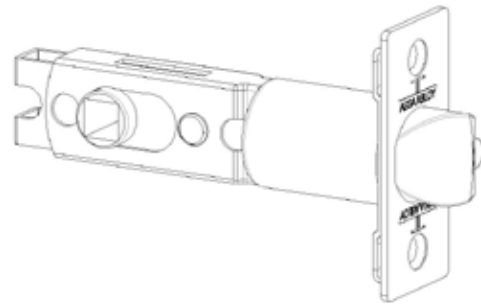

Verrou 516 et 517

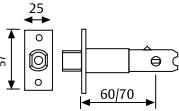
| Standard | Modèle | Finition | Axe |
|---|--------|----------|-------|
|  | P016U0 | LP - CR | 60/70 |
| | | | |

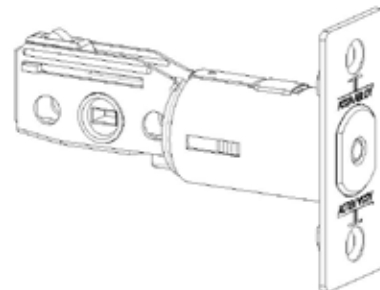

Gâches

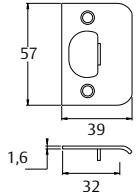
| Standard avec traîne | Modèle | Finition |
|---|--------|----------|
|  | C2500 | HL |
| | C2500 | HN |
| | | |
| | | |

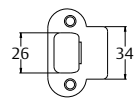
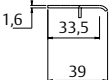
| Bouts ronds avec traîne | Modèle | Finition |
|--|-----------|----------|
|  | CR25 / 34 | HL |
| | CR25 / 34 | HN |
|  | | |
| | | |
| | | |

