

# Key-in-lever locksets



ASSA ABLOY

## Squaring the advantages

- » Multifunctional mechanism for knob or lever, with high component robustness and soft operation.
- » High-end commercial and residential applications.

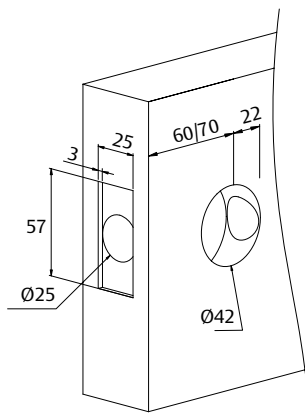

Dimensions in mm

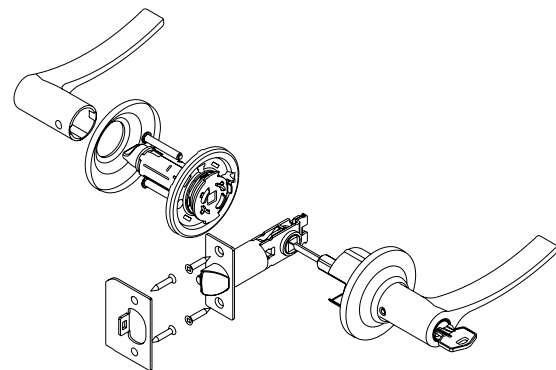







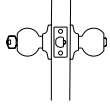
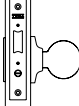
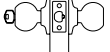

Features	Standard	Special
Technical features	Anti-thrust security pin for functions 0, 1 and 2.	Panic release system: in key models, even when locked, the door can always be opened from inside.
Anti-corrosion resistance ASTM B117/90	CR,CM,NS ... 144 hours LP,LM... 96 hours	
Door thickness	33-45 mm for handles. 33-52 mm for knobs. Except function 07: 40-50mm	Up to 75 mm
ANSI A156.2	Grade 2: 400.000 cycles.	
UL		Up to 1,5 hours of Fire proof
Cylinder	5 pin cylinder with 3 keys.	Security Cylinder: T60, T80, TX80, T10, T12. Masterkeying and keyed alike.
Latch	60/70 Adjustable backset. Latchbolt projection 12,5 mm	127 mm rounded forend.
Accessories	Strike, screws, instructions and assembly template.	Rounded strike.
Packaging units	20	
Reversibility	All knobsets are reversible - Beware with the hands of some handles	

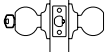
Pour plus d'informations, visitez [www.tesa.es](http://www.tesa.es)  
ou envoyer un e-mail à [marketing@tesa.es](mailto:marketing@tesa.es)

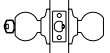
# Key-in-lever locksets

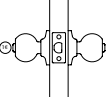
## Functions

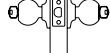
Function	Description	Function	Description
 00	ENTRANCE LOCK: both sides are locked and unlocked by outside key or inside turn-button.	 20	ENTRANCE LOCK: both sides are locked and unlocked by outside key or inside knob. Mortise lock. Applicable with electric strike.
 01	ENTRANCE LOCK: locked and unlocked only by outside key. If locked, inside knob/lever is not active.	 31	SINGLE DUMMY TRIM: screw attachment from inside of the door.
 01AP	ENTRANCE LOCK: locked and unlocked only by outside key. Inside always unlocked.	 32	DOUBLE DUMMY TRIM
 02	STOREROOM LOCK: outside fixed, entrance by key only. Inside always unlocked.	 33	ENTRANCE LOCK: both sides always unlocked. Applicable to mortise locks.
 03	BED AND BATHROOM LOCKS: both sides are locked and unlocked by the inside turn-button. Emergency release outside.	 34	ENTRANCE LOCK: always unlocked. Applicable to mortise locks.
 05	PASSAGE LOCK: both sides always unlocked.		
 07	OFFICE LOCK: key locks and unlocks each side separately. Leaf thickness: 40-50mm		

## Code interpretation

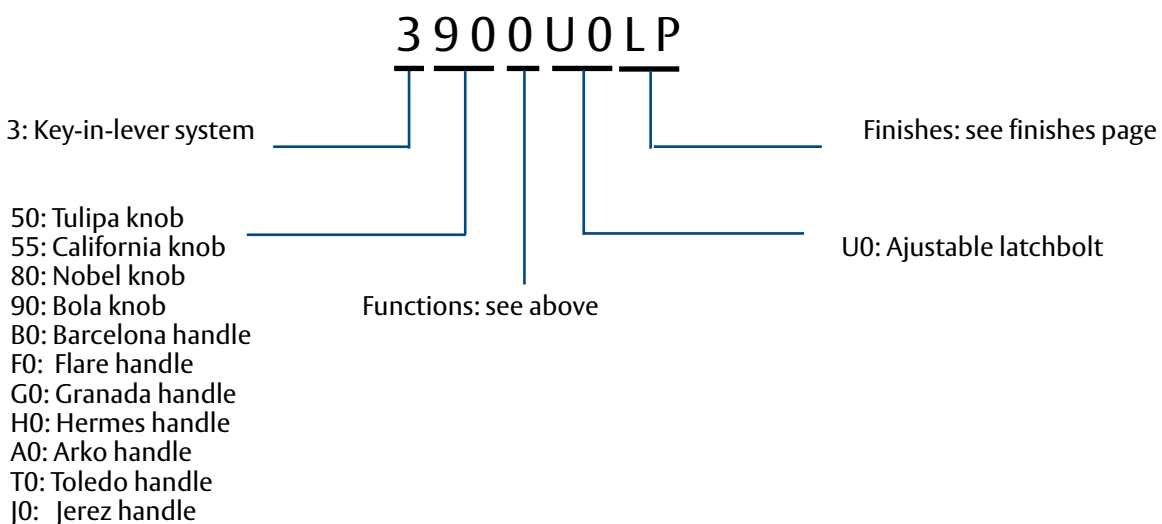

# Key-in-lever locksets

## Handle model

Model	A	B	C	Model	A	B	C
Arko	65	62	112	Hermes	65	62	109
Barcelona	65	62	109	Jerez	65	62	115
Flare	65	62	107	Toledo	65	62	121
Granada	65	62	119				

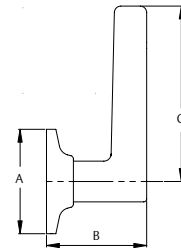

3A00 Arko                      3B00 Barcelona



3F00 Flare                      3G00 Granada



3H00 Hermes                      3J00 Jerez



3T00 Toledo



## 3F00 Flare series

Entrance	Function	Backset	Finish	Packging
	3F00	U0	CM - CR - LM - LP - NS LA - BL - NE	20
Storeroom	Function	Backset	Finish	Packging
	3F02D	U0	CM - CR - LM - LP - NS LA - BL - NE	20
Storeroom	Function	Backset	Finish	Packging
	3F02I	U0	CM - CR - LM - LP - NS LA - BL - NE	20
Bathroom	Function	Backset	Finish	Packging
	3F03	U0	CM - CR - LM - LP - NS LA - BL - NE	20
Passage	Function	Backset	Finish	Packging
	3F05	U0	CM - CR - LM - LP - NS LA - BL - NE	20
Offices	Function	Backset	Finish	Packging
	3F07	U0	CM - CR - LM - LP - NS LA - BL - NE	20
Pull lever	Function	Backset	Finish	Packging
	3F34D	00	CM - CR - LM - LP - NS LA - BL - NE	20
Single spindle	Function	Backset	Finish	Packging
	3F34I	00	CM - CR - LM - LP - NS LA - BL - NE	20

