

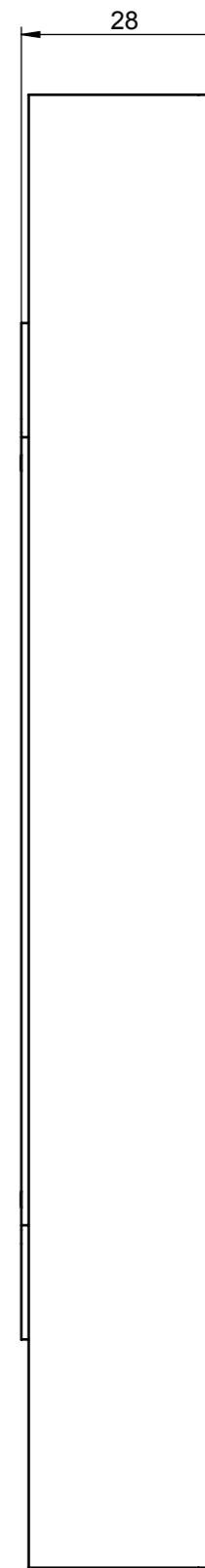

This document is our property and shall not without our permission be altered, copied, used for manufacturing or communicated to any other person or company.

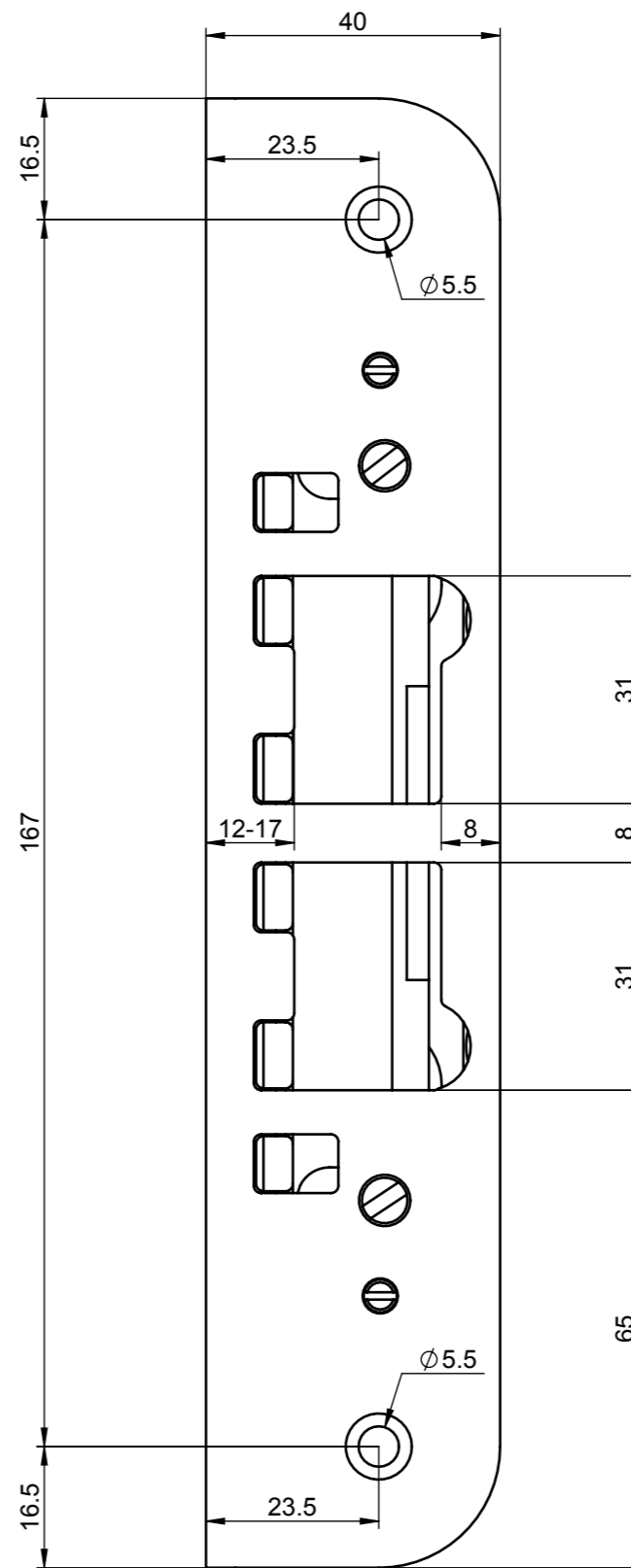
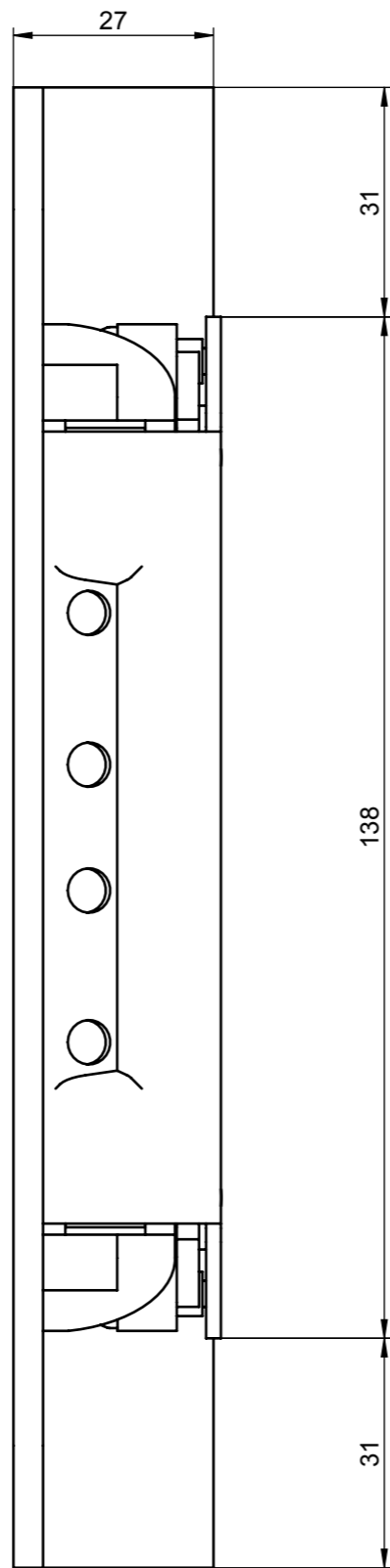
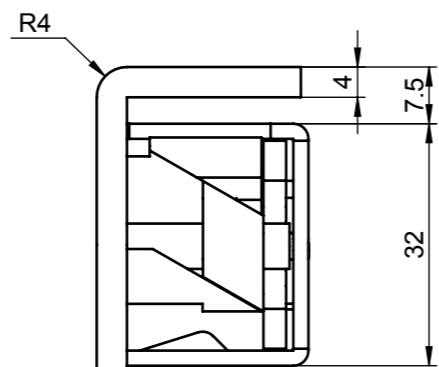
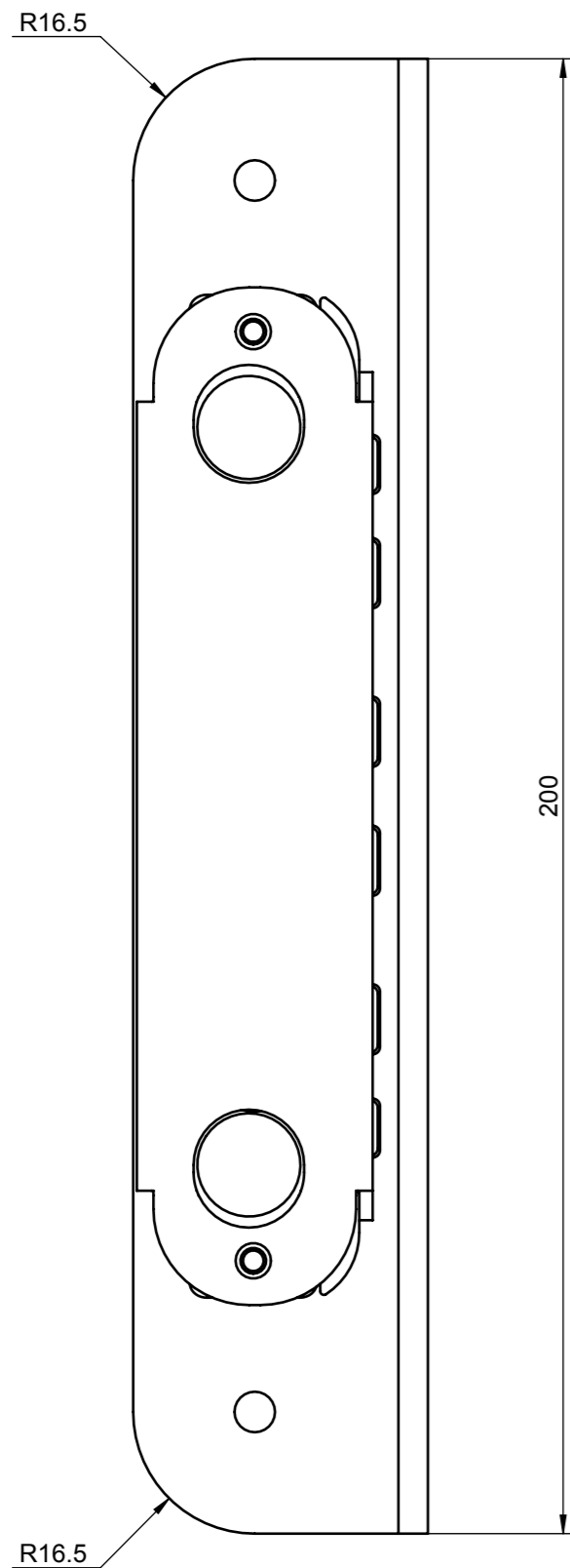

Surface: 456466		Material:			General tolerance: ISO 2768-mH	
Volume:	Weight:	Surface area:	created: 17.03.2015 JK	designed by:	changed by:	Scale: 1:1 (A3)
 ABLOY Oy An ASSA ABLOY Group brand			ABLOY LP722			Projection: 
			Document ID			Rev.: 1

Part/assy:

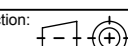
Configuration:Default

SHEET 1 OF 1