

This document is our property and shall not without our permission be altered, copied, used for manufacturing or communicated to any other person or company.

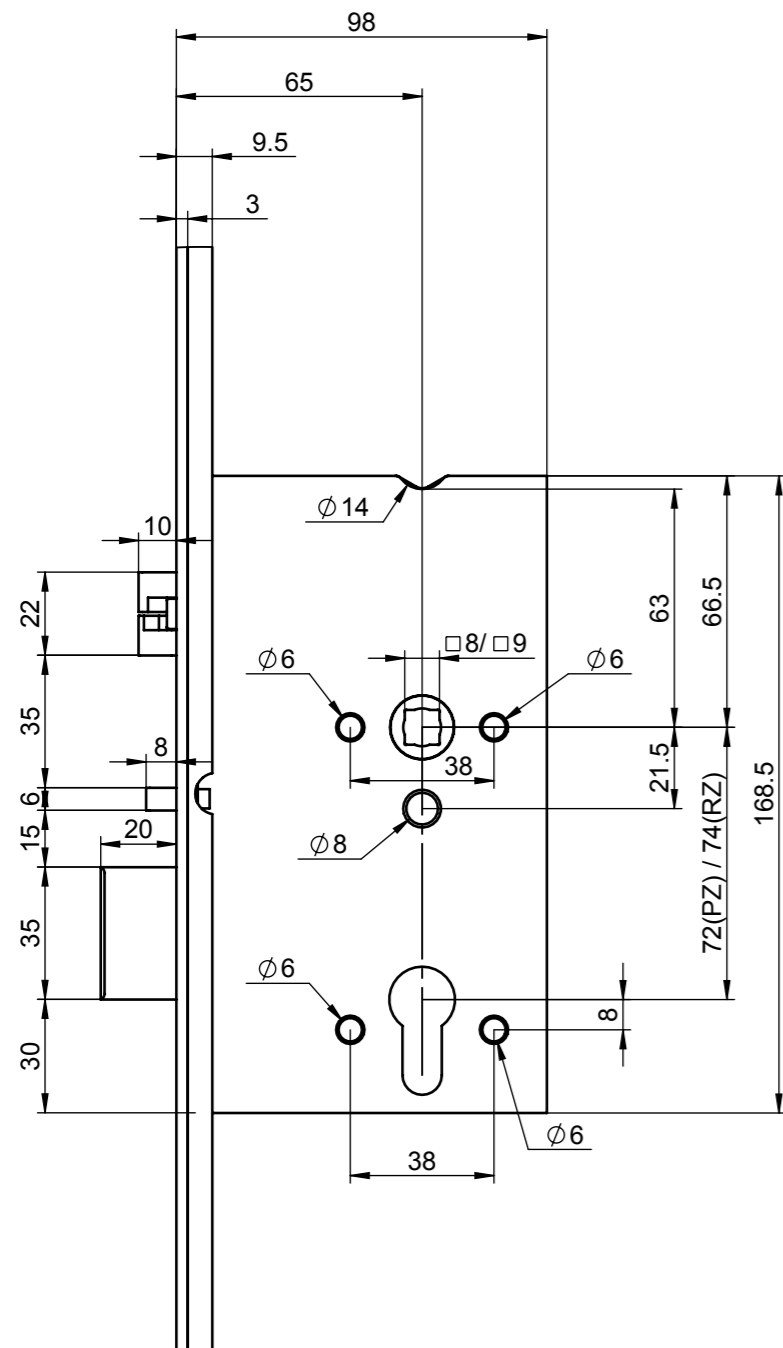

DETAIL A
SCALE 1 : 2

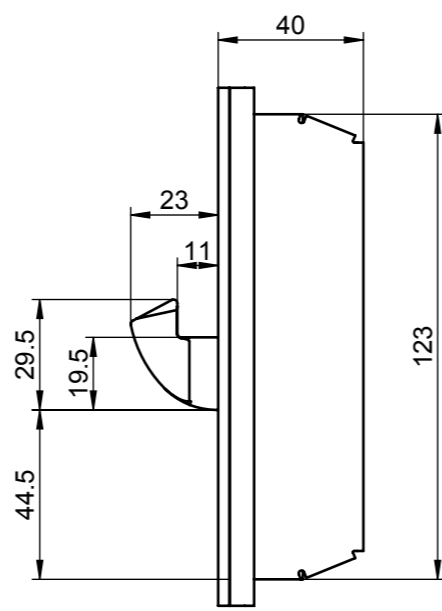

DETAIL B
SCALE 1 : 2

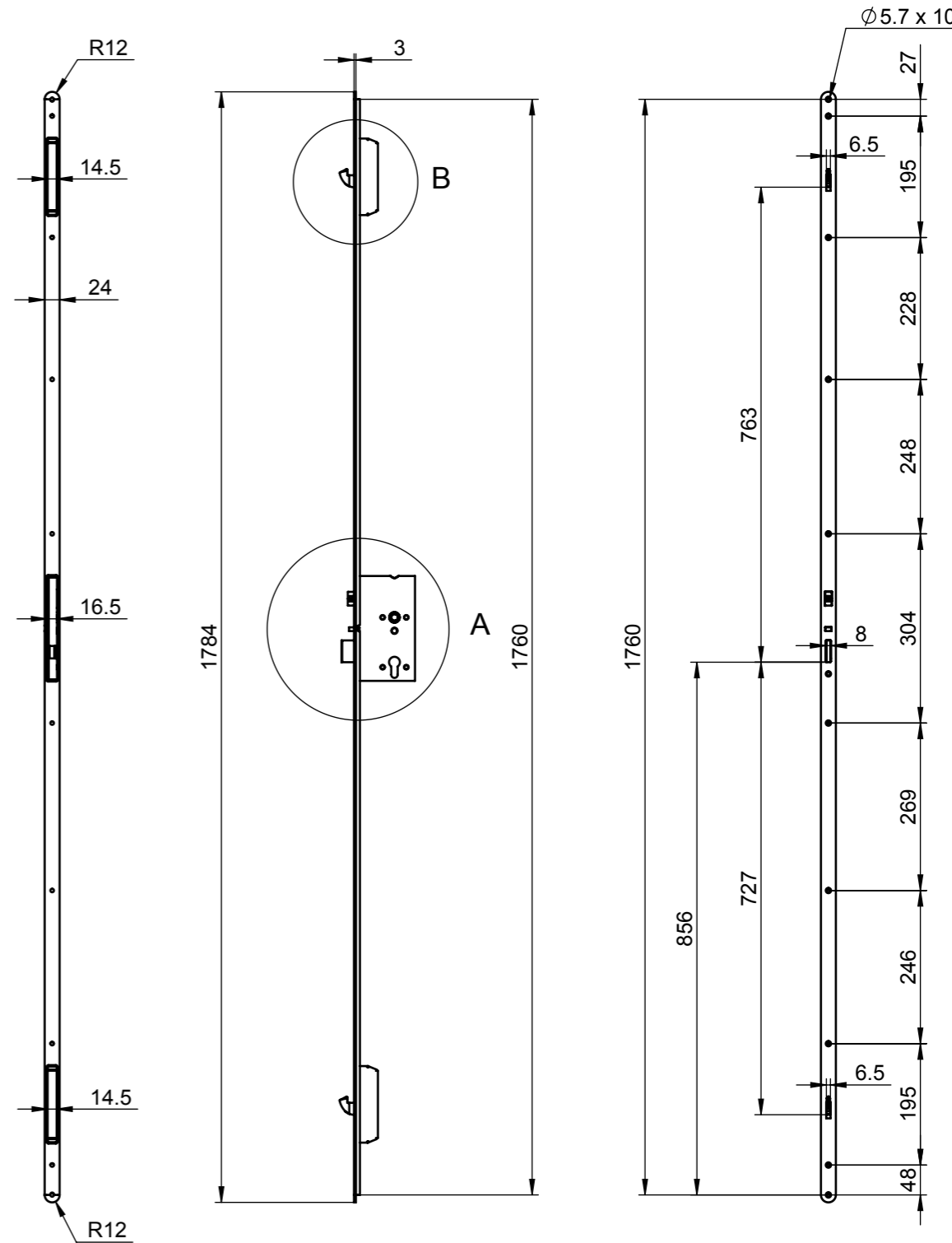

Surface: 456466			Material:			General tolerance: ISO 2768-mH		
Volume:	Weight:	Surface area:	created: 19.04.2016 JK	designed by:	changed by:	Scale: 1:10 (A3)	Projection: 	
 Abloy Oy An ASSA ABLOY Group brand			ABLOY MP520 / 65 / 1760 / FLAT			Alternate ID		
						Document ID		Rev.: 1

Part/assy:

Configuration:Default

SHEET 1 OF 1