

CYE037

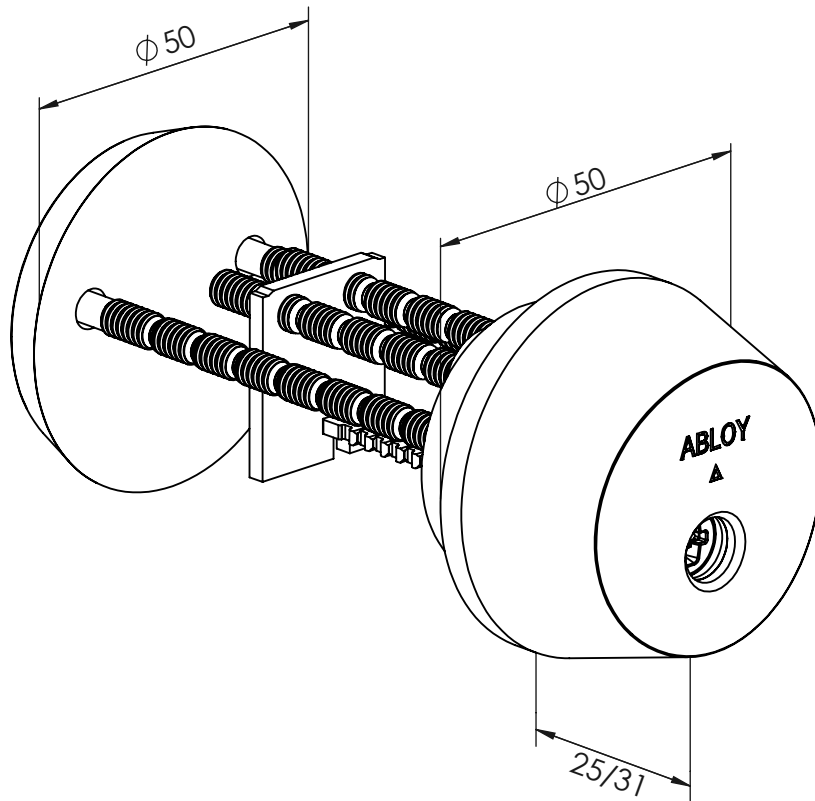

Copyright © Abloy Oy Joensuu Factory 2014

Drawn by:	Country	Drawing Number	rev.	ALT ID:	Date
ANTTIKU		D000724513-900	1	DM-01561	2018-09-13

An ASSA ABLOY Group brand **ASSA ABLOY**

Approved 2018-11-16