

CYE060

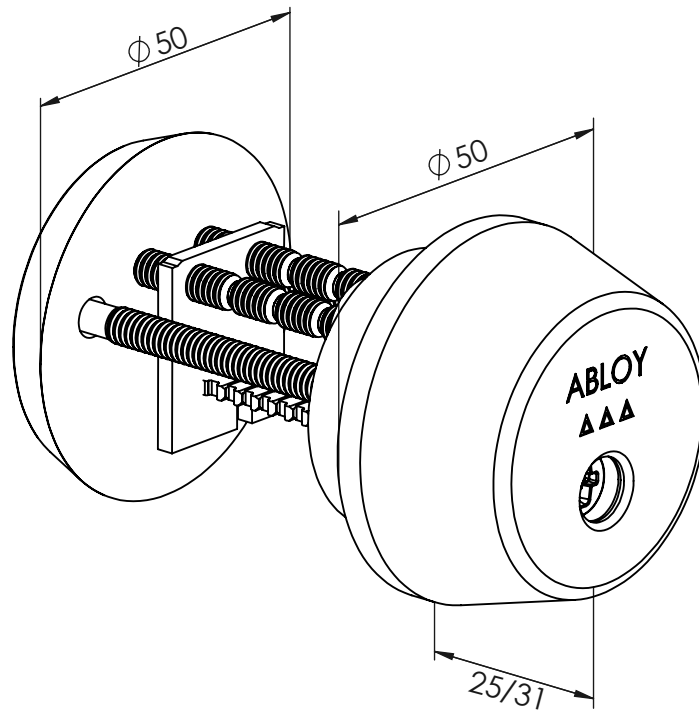

Copyright © Abloy Oy Joensuu Factory 2014

Drawn by:	Country	Drawing Number	rev.	ALT ID:	Date
ANTTIKU		D000724539-900	1	DM-01569	2018-09-13