

Key-in-lever locksets



ASSA ABLOY

Squaring the advantages

- » Multifunctional mechanism for knob or lever, with high component robustness and soft operation.
- » High-end commercial and residential applications.

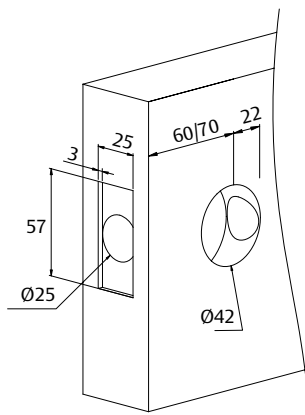

Dimensions in mm

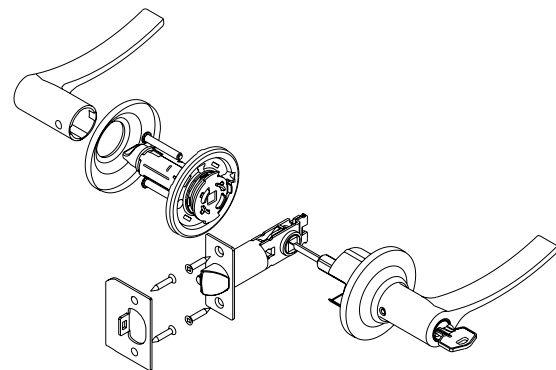







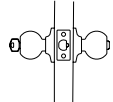
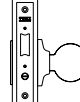
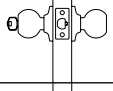

Features	Standard	Special
Technical features	Anti-thrust security pin for functions 0, 1 and 2.	Panic release system: in key models, even when locked, the door can always be opened from inside.
Anti-corrosion resistance ASTM B117/90	CR,CM,NS ... 144 hours LP,LM... 96 hours	
Door thickness	33-45 mm for handles. 33-52 mm for knobs. Except function 07: 40-50mm	Up to 75 mm
ANSI A156.2	Grade 2: 400.000 cycles.	
UL		Up to 1,5 hours of Fire proof
Cylinder	5 pin cylinder with 3 keys.	Security Cylinder: T60, T80, TX80, T10, T12. Masterkeying and keyed alike.
Latch	60/70 Adjustable backset. Latchbolt projection 12,5 mm	127 mm rounded forend.
Accessories	Strike, screws, instructions and assembly template.	Rounded strike.
Packaging units	20	
Reversibility	All knobsets are reversible - Beware with the hands of some handles	

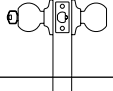
Pour plus d'informations, visitez www.tesa.es
ou envoyer un e-mail à marketing@tesa.es

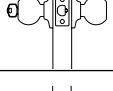
Key-in-lever locksets

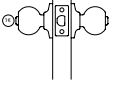
Functions

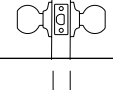
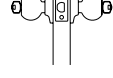
Function	Description	Function	Description
 00	ENTRANCE LOCK: both sides are locked and unlocked by outside key or inside turn-button.	 20	ENTRANCE LOCK: both sides are locked and unlocked by outside key or inside knob. Mortise lock. Applicable with electric strike.
 01	ENTRANCE LOCK: locked and unlocked only by outside key. If locked, inside knob/lever is not active.	 31	SINGLE DUMMY TRIM: screw attachment from inside of the door.
 01AP	ENTRANCE LOCK: locked and unlocked only by outside key. Inside always unlocked.	 32	DOUBLE DUMMY TRIM
 02	STOREROOM LOCK: outside fixed, entrance by key only. Inside always unlocked.	 33	ENTRANCE LOCK: both sides always unlocked. Applicable to mortise locks.
 03	BED AND BATHROOM LOCKS: both sides are locked and unlocked by the inside turn-button. Emergency release outside.	 34	ENTRANCE LOCK: always unlocked. Applicable to mortise locks.
 05	PASSAGE LOCK: both sides always unlocked.		
 07	OFFICE LOCK: key locks and unlocks each side separately. Leaf thickness: 40-50mm		

Code interpretation

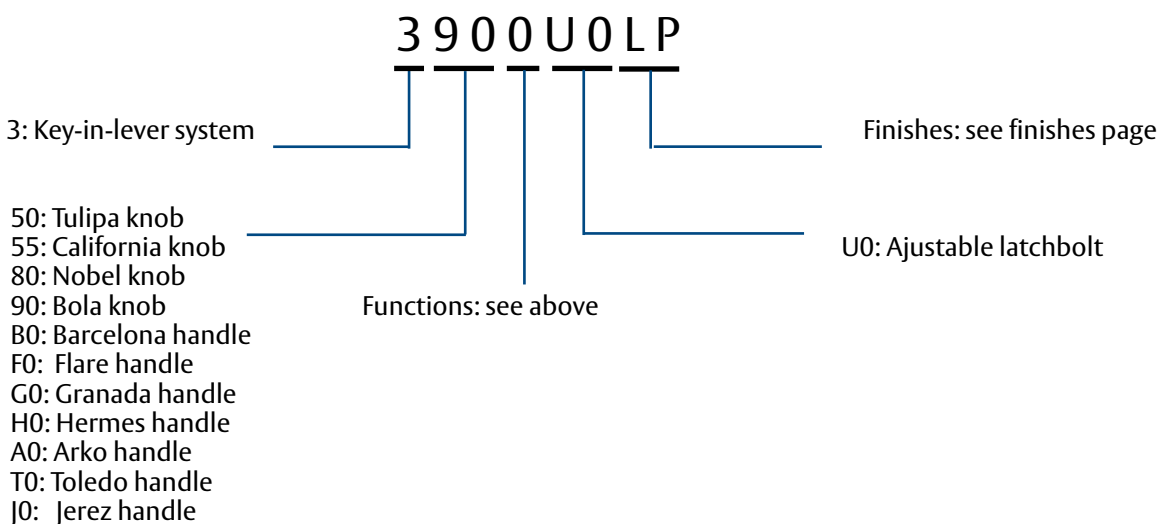

Sistema cuadradillo

Serie Barcelona 3B00

Entrada	Función	Entrada	Acabado	Embalaje
	3B00	U0	CM - CR - LM - LP - NS LA - BL - NE	20
Aula	Función	Entrada	Acabado	Embalaje
	3B02D	U0	CM - CR - LM - LP - NS LA - BL - NE	20
Aula	Función	Entrada	Acabado	Embalaje
	3B02I	U0	CM - CR - LM - LP - NS LA - BL - NE	20
Baño	Función	Entrada	Acabado	Embalaje
	3B03	U0	CM - CR - LM - LP - NS LA - BL - NE	20
Paso	Función	Entrada	Acabado	Embalaje
	3B05	U0	CM - CR - LM - LP - NS LA - BL - NE	20
Oficina	Función	Entrada	Acabado	Embalaje
	3T07	U0	CM - CR - LM - LP - NS LA - BL - NE	20
Pomo - cuadradillo	Función	Entrada	Acabado	Embalaje
	3B34D	00	CM - CR - LM - LP - NS LA - BL - NE	20
Pomo - cuadradillo	Función	Entrada	Acabado	Embalaje
	3B34I	00	CM - CR - LM - LP - NS LA - BL - NE	20

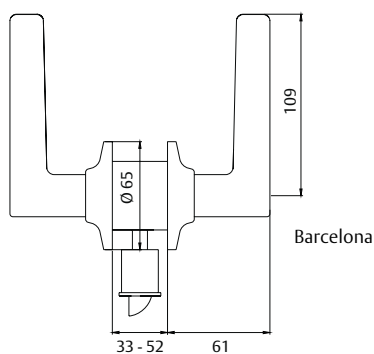

Serie Arko 3A00

Entrada	Función	Entrada	Acabado	Embalaje
	3A00	U0	CM - CR - LM - LP - NS LA - BL - NE	20
Aula	Función	Entrada	Acabado	Embalaje
	3A02D	U0	CM - CR - LM - LP - NS LA - BL - NE	20
Aula	Función	Entrada	Acabado	Embalaje
	3A02I	U0	CM - CR - LM - LP - NS LA - BL - NE	20
Baño	Función	Entrada	Acabado	Embalaje
	3A03	U0	CM - CR - LM - LP - NS LA - BL - NE	20
PAso	Función	Entrada	Acabado	Embalaje
	3A05	U0	CM - CR - LM - LP - NS LA - BL - NE	20
Oficina	Función	Entrada	Acabado	Embalaje
	3A07	U0	CM - CR - LM - LP - NS LA - BL - NE	20
Pomo - cuadradillo	Función	Entrada	Acabado	Embalaje
	3A34D	00	CM - CR - LM - LP - NS LA - BL - NE	20
Pomo - cuadradillo	Función	Entrada	Acabado	Embalaje
	3A34I	00	CM - CR - LM - LP - NS LA - BL - NE	20

